

Nominal Size W x H x D (in)	Actual Size W x H x D (in)	Part Number	Capacity (CFM)	Resistance (in W.G.)	Media Area (sq ft)	Carton Qty	Weight per Carton (lbs)
12x24x2	11-3/8 x 23-3/8 x 1-3/4	110-502-003	500	0.28	21	12	19
16x20x2	15-3/8 x 19-3/8 x 1-3/4	110-502-005	550	0.28	24	6	21
16x25x2	15-3/8 x 24-3/8 x 1-3/4	110-502-006	700	0.28	29	6	24
18x24x2	17-3/8 x 23-3/8 x 1-3/4	110-502-008	750	0.28	32	6	23
20x20x2	19-3/8 x 19-3/8 x 1-3/4	110-502-002	700	0.28	29	6	24
20x24x2	19-3/8 x 23-3/8 x 1-3/4	110-502-007	825	0.28	35	6	26
20x25x2	19-3/8 x 24-3/8 x 1-3/4	110-502-004	875	0.28	37	6	27
24x24x2	23-3/8 x 23-3/8 x 1-3/4	110-502-001	1000	0.28	42	6	31

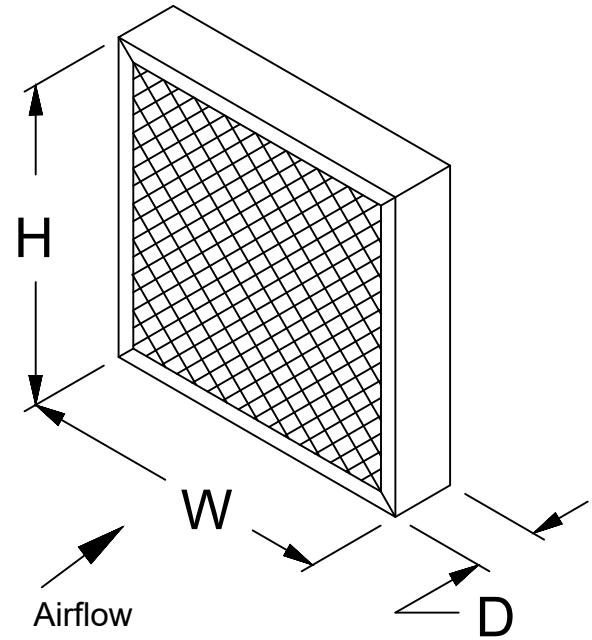

**Standard Construction:**

1. Gradient Density Microfiberglass Media
2. Frame: 24 gage Aluminized Steel
3. Media Separators: Corrugated Aluminum with hemmed safety edge
4. Faceguard on Upstream and Downstream Side of Filter

**Specifications:**

1. MERV 11 ( 60-65% ) ( ASHRAE Standard 52.2-2017 )
2. Final Resistance: 1.5" W.G.
3. Final Resistance: 1.2" W.G. in applications where temperature exceeds 350 F
4. Classified UL Standard 900
5. Maximum Operating Temperature: 750 F ( 399 C )
6. Tolerance: Height & Width - +0 / -1/8"
7. Tolerance: Depth - +/- 1/16"

**Notes:**

1. All Dimensions are in Inches Unless Otherwise Noted
2. Drawing Not to Scale



**Multi-Cell CS 2"  
MERV 11**

REV  
LTR

REVISION

BY /  
DATE

8401 Air Commerce Drive - Louisville KY 40219  
Phone: (502) 634-4796 FAX: (502) 637-2280

Drawn By: B. Chamberlain  
Date: December 13, 2022

Revision